

VW
Continental

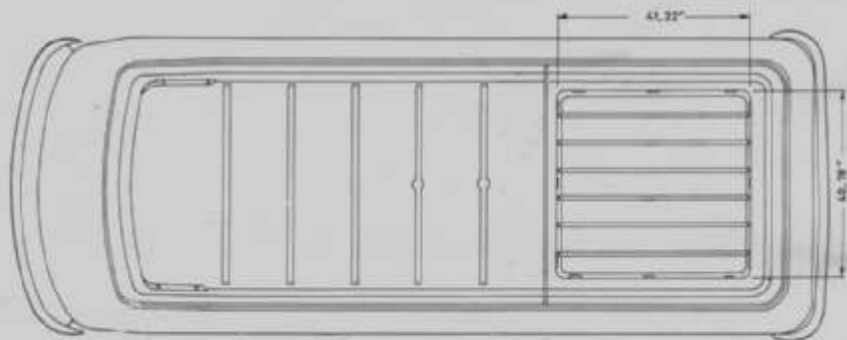

Manual for Camping equipment

Edition 8/72

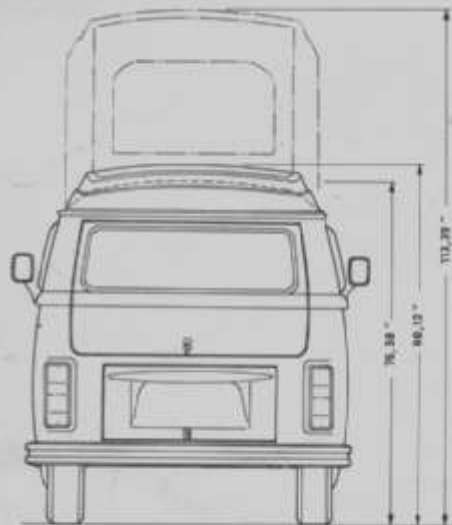

Continental with pop-up roof
and luggage rack

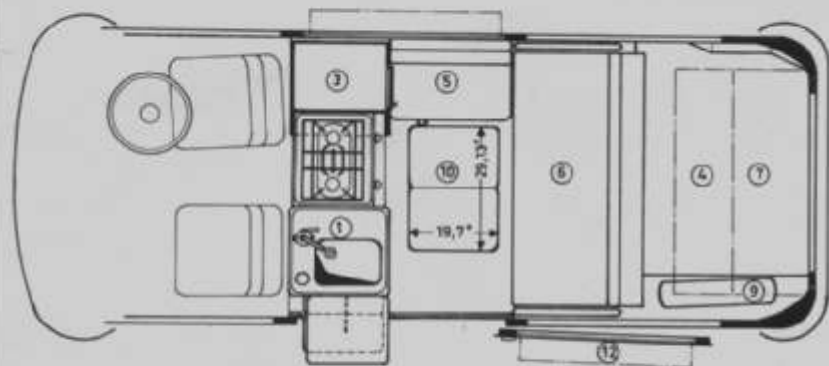

Living

- ① Wash unit
- ② Food cabinet
- ③ Wardrobe
- ④ Linen cabinet
- ⑤ Upholstered side seat
- ⑥ Rear upholstered bench
- ⑦ Upholstery above engine compartment
- ⑧ Stool
- ⑨ Spare wheel cover
- ⑩ Dining table
- ⑪ Child's bed
- ⑫ Louvered windows

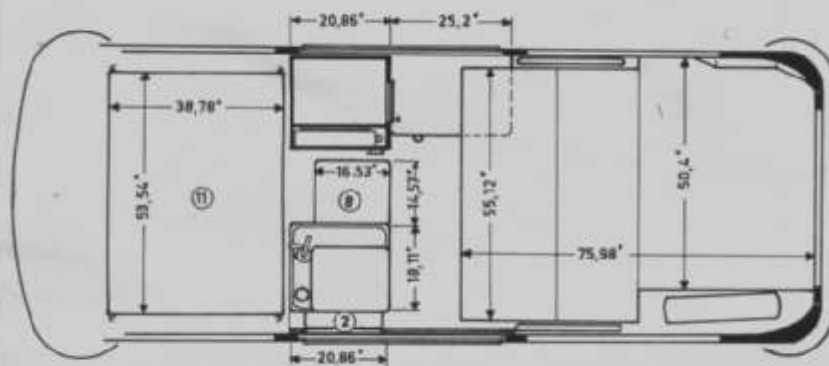

Sleeping

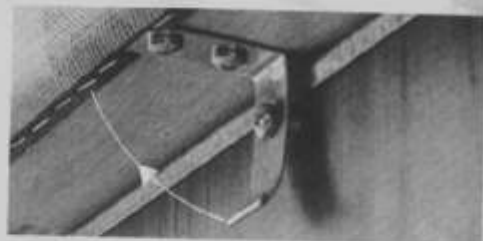

Rear bench seat

Under the rear bench seat there is a built in storage compartment. It is accessible in two ways, either by lifting the unbolted seat or by means of a hatch in the front.

In order to convert the back seat into a double bed the swivel table top has to be folded down.

Unfasten and lift seat, thus releasing the backrest.

After pulling the seat out the backrest, seat and rear compartment form the double bed.

To reassemble, lift seat into catch and push whole unit into seating position. It locks automatically.

Note

Secure hatch of storage compartment before setting vehicle into motion.
Do not forget safety belts.

Important

Insure that seat rests securely on seat box.

Hatch can only be opened by pulling handle towards you.

When ordering spare parts please state type and running production number of the equipment. You will find this data on the typed label at the bottom of the box of back seat.

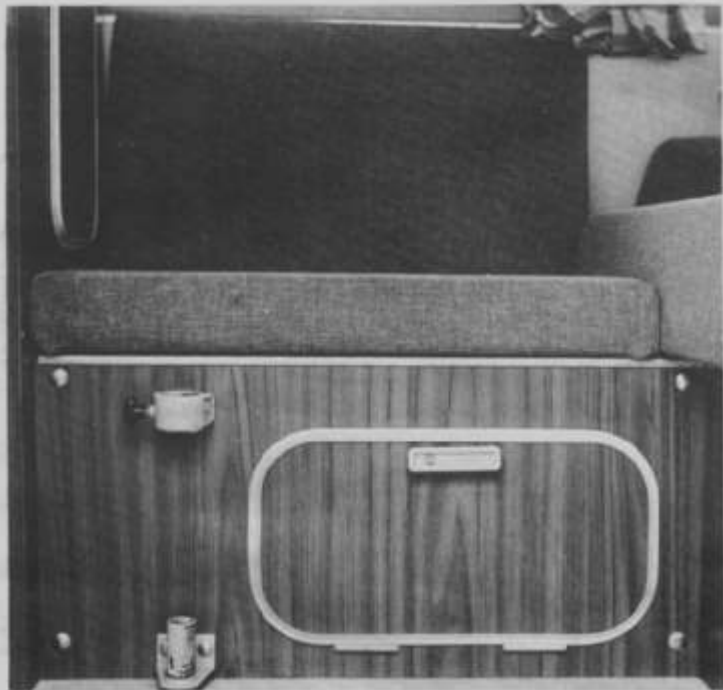
**Side seat**

It is situated between front wardrobe and back seat.
The storage compartment is accessible by lifting the seat or opening the hatch.

Note

Seat must not be used when vehicle is in motion.
Ensure that seat rests securely on box.
Hatch can only be opened by first pressing the button in the handle.

Stool

It is situated between the cupboard and the wardrobe.
Secure while vehicle is in motion by pulling strap fixed to it through noose on cupboard and fasten tightly.

Warning

Stool must not be used while vehicle is in motion.



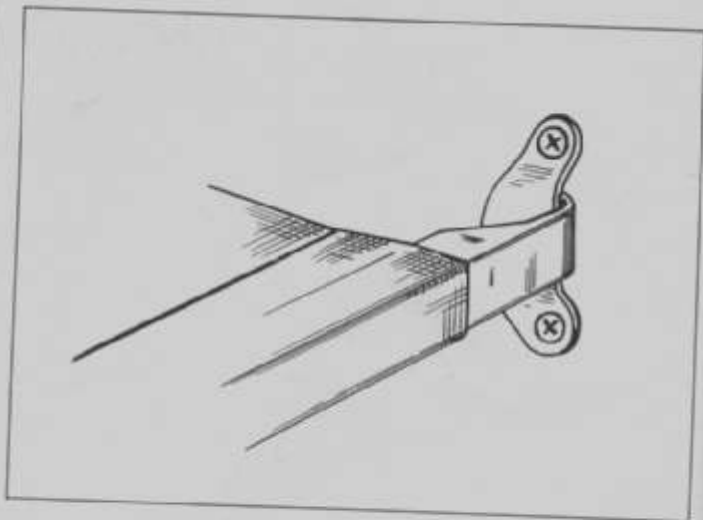

**Childrens bunk in driver's compartment.
Installation of bunk.**

Unroll bunk and hook, first front and then back bar onto the fixings (brackets) mounted on the door pillar.

Note

Maximum weight on bunk 90 lbs.

Important

Before using make sure bars are secured.

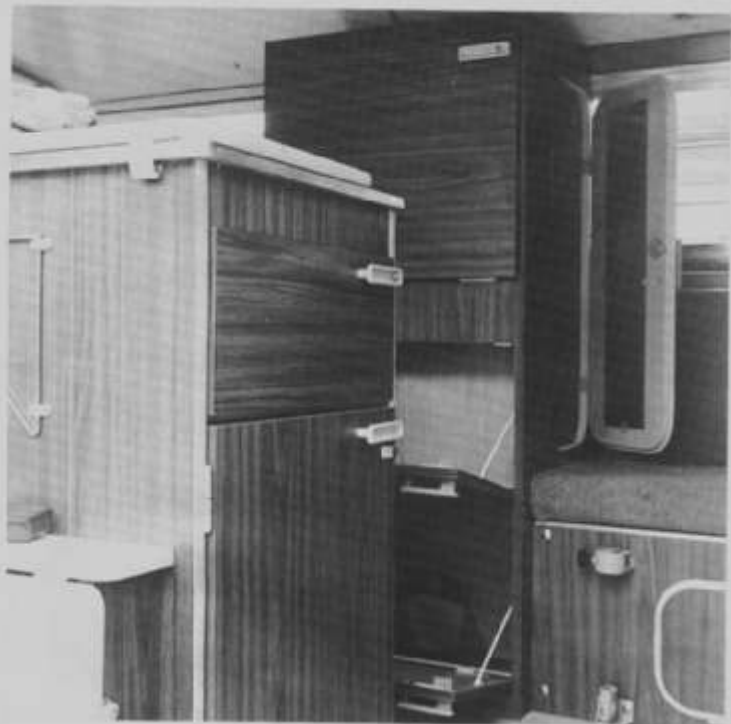

Wardrobe behind partition of driver's compartment.

Contains foldaway cooker which opens into the aisle.
Two 3 kg bottles can be fixed in brackets in space provided below
cooker.

A mirror is fixed inside door of the wardrobe.



Note

Close wardrobe door and hatches before setting vehicle in motion.
Do not cover air vents of compartment for gaz bottles.

Important

Door and hatches can only be opened by first pulling the recessed
handle towards you.

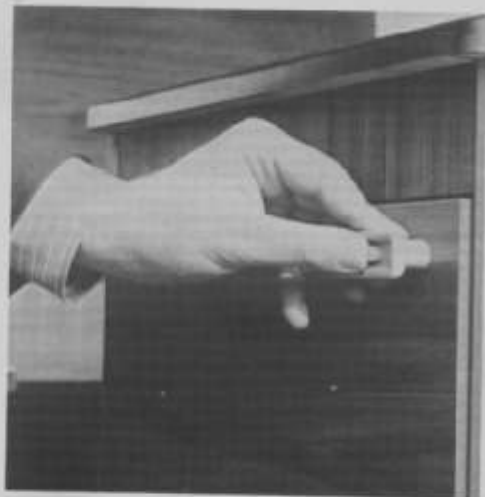

Storage Cupboards

It is situated behind the passenger seat. It consists of an insulated food box, a sink, the drain, the waterpump and tank and the filling spout.

The food box keeps the temperature required by means of dry ice or ice blocks.

A tray is installed to prevent the blocks of ice from sliding while vehicle is in motion.

The water of the melting ice runs off through a drip bowl and from there through a waste pipe outside. There is a 28 litre water tank in the rear part.

The tank is emptied by opening a drain screw underneath the car. The water inlet is placed on the left hand side of the cabinet, and is covered with a plastic cap. Next to it a hand operated waterpump is installed.

The sink is covered by a lid, both sides of which are plated with heat and scratch resistant plastic. By lifting it off to the left, it creates an additional worktop.

The dish water runs off outside through a waste pipe. Cutlery can be stored in a box inside the cabinet under the sink.

Note

Do not place articles on open hatch.

Close hatch and door of food box before setting vehicle in motion.

Important

When using storage cupboard please note: Tap and handle of waterpump must be turned towards the passenger seat. Only then the lid is covering the sink can be folded down properly.

Keep cap on water inlet at all times.

Hatch of cabinet under sink can only be opened by pulling handle towards you.

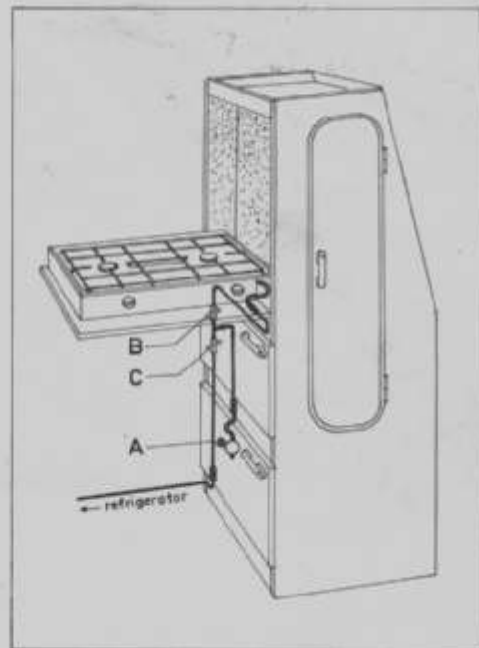
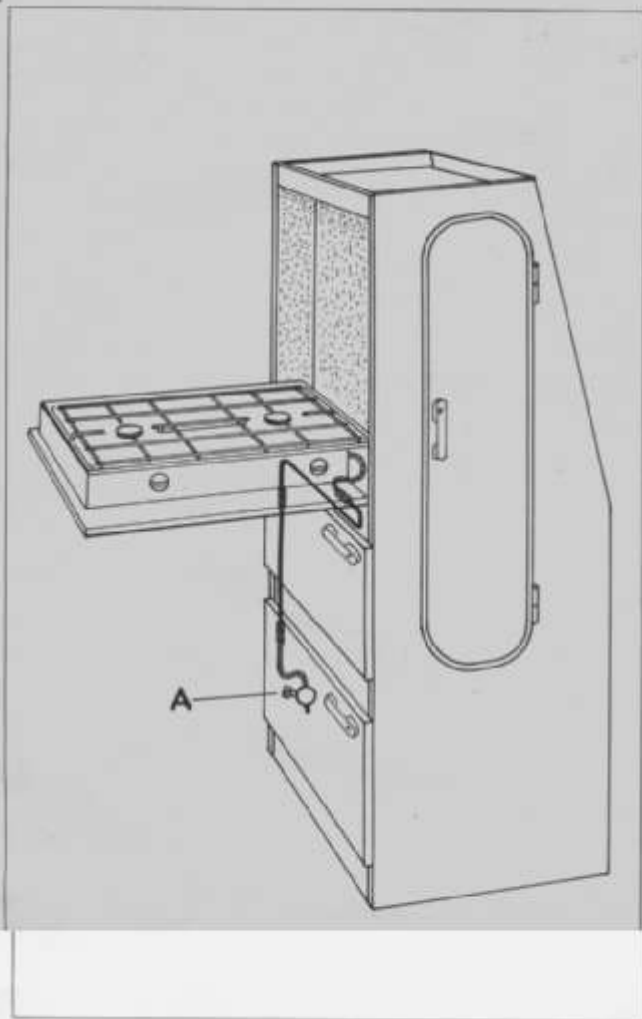

Gaz-Cooker und gas supply for refrigerator

Instructions for Gaz installation:

1. Open valve (A) at regulator.
2. Open stop cock (B) for cooker or (C) for refrigerator.
3. Close stop-cocks after use in the absence of a refrigerator valve at regulator is used as stop-cock for cooker.

Operation of cooker and refrigerator is explained in manuals, supplied with the equipment.

Note

Do not use gas equipment while vehicle is in motion.
Close stop-cocks immediately after use.



Wash-Stand with Folding Table

It is situated on the left hand side of the storage cupboard. By pulling the table up it locks automatically. Press locks to fold table down again.

Note

Fold down table before closing the sliding door. When there is a refrigerator installed the wash-stand is narrower.

Rear cupboard

It is fixed underneath the roof above the engine compartment. It is accessible through a front hatch.

Note

Do not use cupboard to store heavy articles. Close flap before setting vehicle in motion.

Important

Hatch of cupboard can only be opened by first pulling handle towards you.

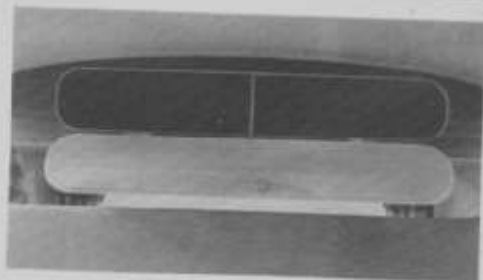
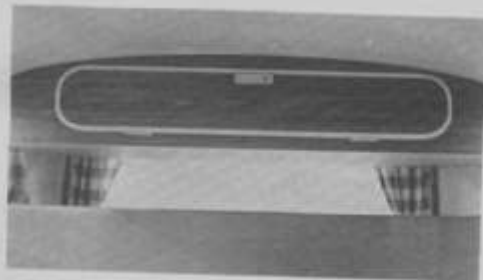

Louvered Windows

The Continental is equipped with two louvered windows; one in the sliding door and the other on the opposite side of the vehicle. Each louvered window has a removable screen. To remove the screen, push the screen frame upward and pull outward. To replace the screen, reverse this procedure.

Vent Adjustment: If a louvered vent does not close down properly, adjusting holes have been provided. These holes are in the pivot brackets. There are two screws holding each end of the vent to the pivot bracket. The upper screw must always keep its position, while the lower one is for adjusting the vent closure. The lower screw should move up to the next hole to tighten the closure or down to relieve this closure, if it has been adjusted too tight.

Caution

Do not remove all four screws holding a louver vent unless you wish to remove it from the window frame for replacement of glass.

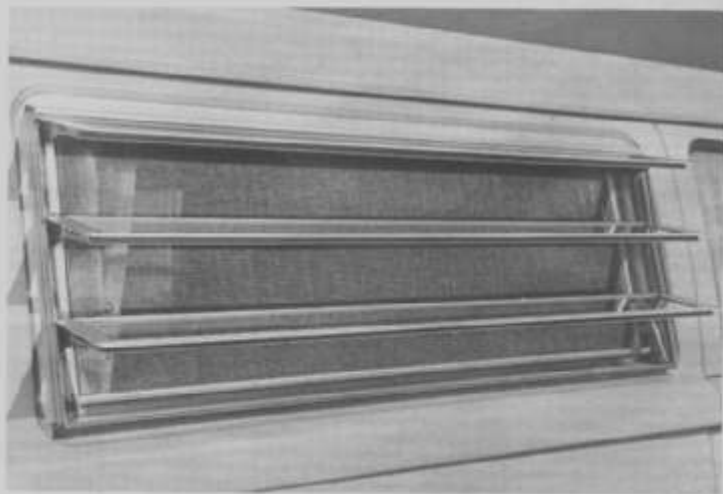
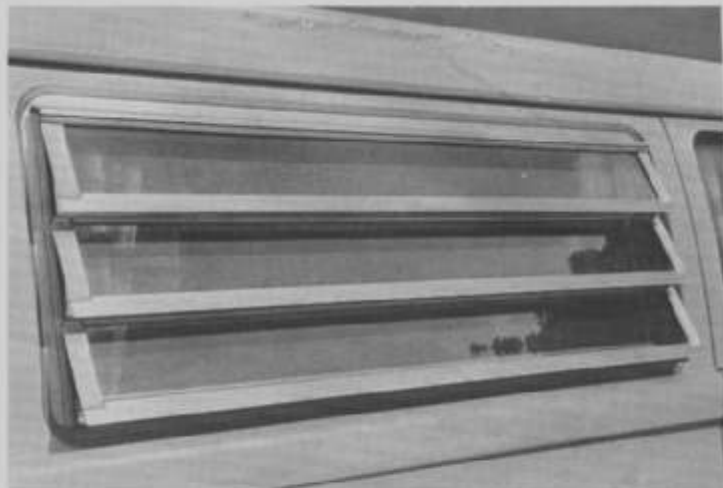



Dining table, Swivel-mounted

The swivel-foot is mounted on the box of the side seat.

To swing table loosen tun-wheels first.

The table top consists of two parts and can be folded thus allowing more space to move in the vehicle.

Important

Hatch can only be opened by first pulling handle towards you.



Curtains

The curtains in the driver's compartment are fixed with patent fasteners.

All other curtains can simply be drawn.





Mosquito net

The mosquito net can be installed with the rear lid open. To install the net, simply press the snaps in the proper locations. The lid can be closed with the mosquito net installed.

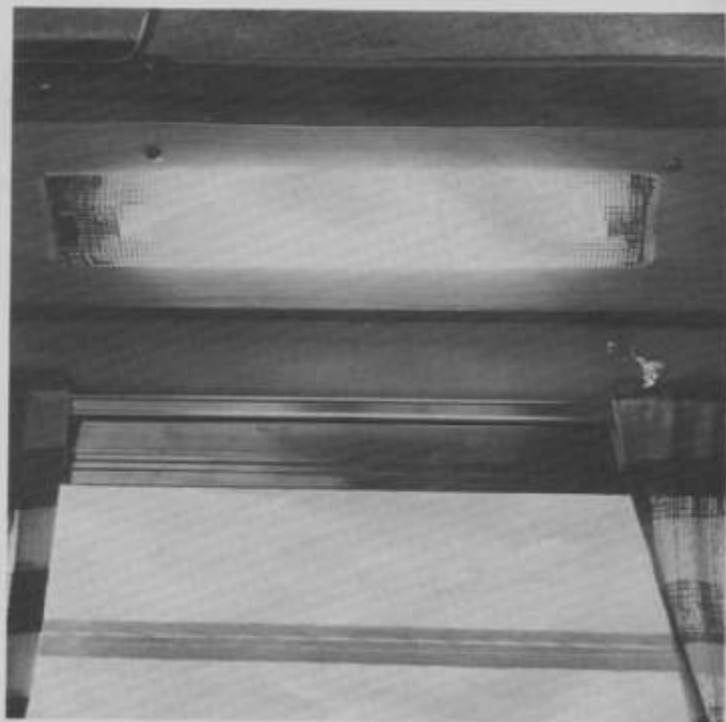

Flourescent Light

Light is supplied by a flourescent light above the side seat. Its current is supplied by the battery of the vehicle.

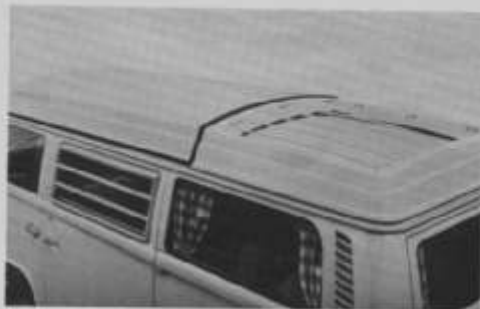

The Pop-Up Roof

A Polyester hood covers the entire roof space of the continental. The front part forms the pop-up roof. To lift unfasten rubber latches and push up until both supports lock.

To lower reverse actions.

The rim is padded with a rubber beading.

The part between the raised roof and the vehicle is made of canvas. When raised it forms a separate sleeping compartment. On either side and at the rear there is a window fitted with fly net and removable canvas flap.

The rear flap is also used to unload and load the luggage rack.

Double bunk for children under the pop-up roof

It is situated in the roof compartment.

It can be taken down when not in use and strapped up with rubber latches.

Note

Do not jam canvas top when lowering roof.

Lower roof and secure setting vehicle in motion.

Important

Maximum weight on bunk - 180 lbs.



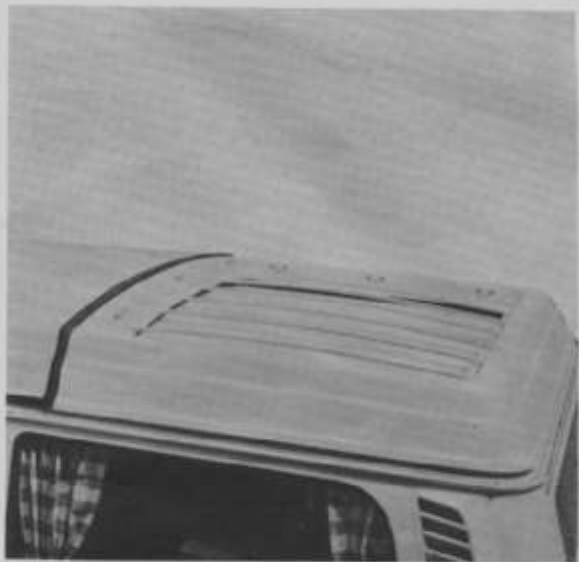
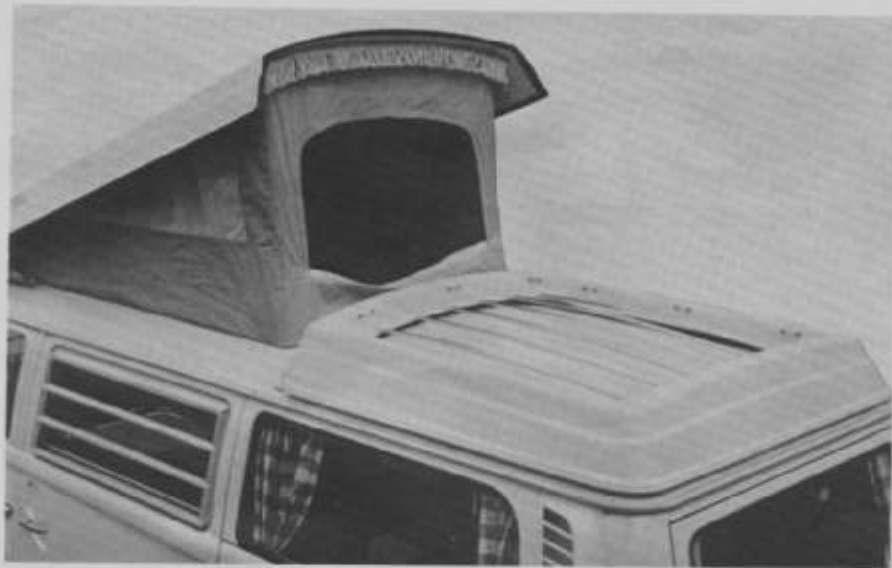

Luggage Rack

Situated on the back part of the vehicle it is bolted to the roof. Hooks on the inside of the rim serve to secure load.

Note

Maximum capacity: 110 lbs.

A hint

Rack can be loaded through rear opening of the canvas in pop-up roof when latter is raised.

Front Tent

Instructions to pitch self-supporting tent:

- a) Erect front frame with poles (8 and 9) green angle poles (2 and 3) centre part (1) and two ridge-pieces (4).
- b) Erect rear frame with poles (6 and 9) red angle-poles (5 and 7) centre part (5) and two ridge pieces (4).
- c) Connect front and rear frame with roof poles (4).
- d) Raise frame to body height with poles 8 and 9.
- e) Place canvas below frame-work, unfold and fix to poles with nooses (23) Picture A.
- f) Raise poles 8 and 9 so that tent just touches ground.
- g) Peg tent to ground (11) and fix struts with pegs (13).
- h) The front flap can be raised with poles 15 to form a sun roof again using struts and pegs (13).
- i) To connect tent and vehicle clip apse (16) to spout (18) of the vehicle roof (Picture B).
- j) Peg side parts (20) to ground and hook bottom part (22) onto the motor caravan with 21, 24 and 25 (Picture C).
- k) During heavy rain unfasten one of the nooses (23) so that the water can run off the roof freely.



